

DETTAGLIO A
SCALA 1 : 1

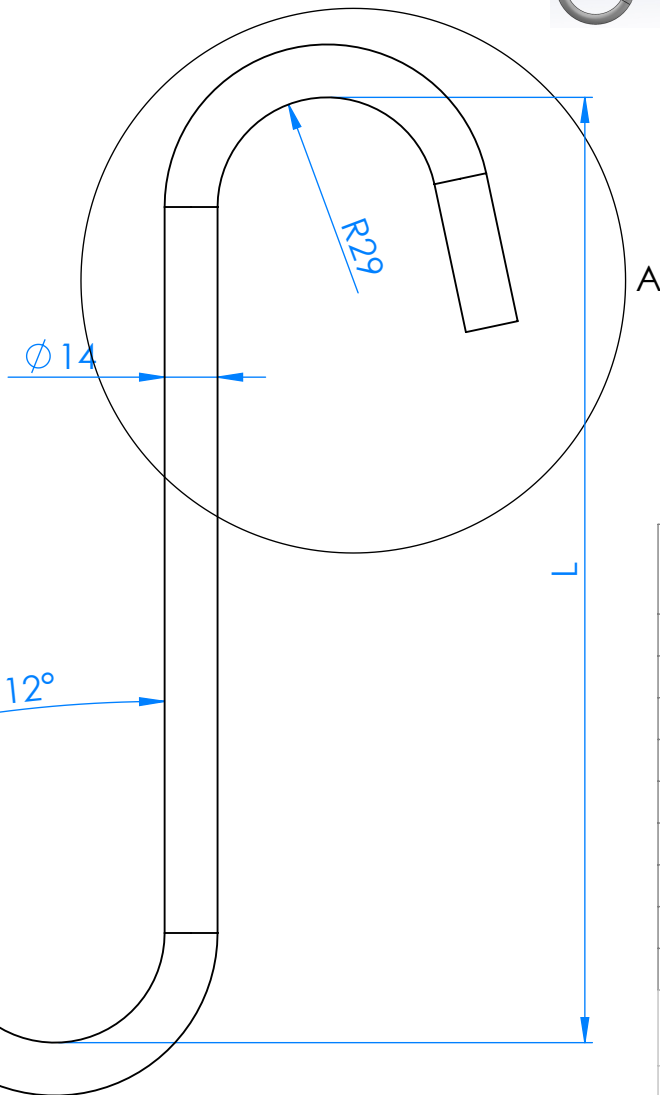

CODICE CODE	L(mm)
D14L200-C180.C	200
D14L250-C180.C	250
D14L300-C180.C	300
D14L400-C180.C	400
D14L500-C180.C	500
D14L600-C180.C	600
D14L700-C180.C	700
D14L800-C180.C	800
D14L1000-C180.C	1000
DESCRIZIONE / DESCRIPTION GANCIO ACCIAIO "S355JR" Ø14, PIEGA STANDARD "C" ROT -180° STEEL HOOK "S355JR" Ø14, STANDARD BENDING "C" TURN -180°	
MATERIALE / MATERIAL S355JR Laminato/S355JR Hot Rolled	
	SCALA / SCALE 1:2
	FORMATO / SHEET SIZE A4

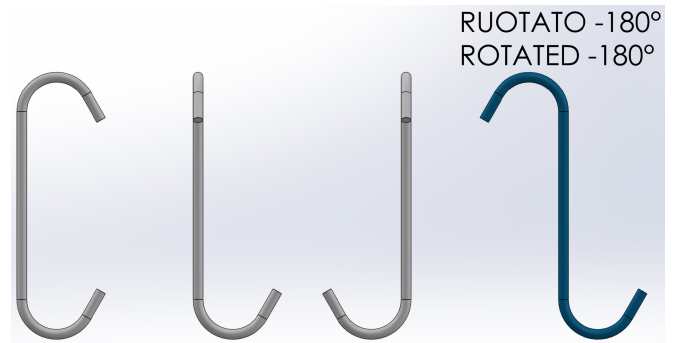
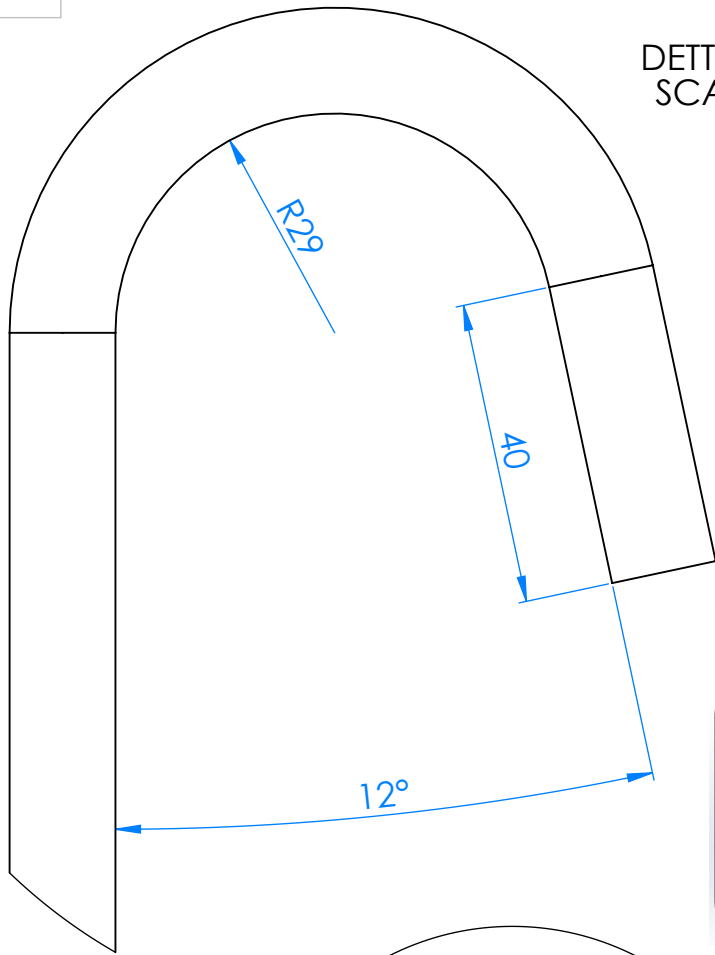

Rostirolla s.r.l.