

DETTAGLIO A
SCALA 1 : 1

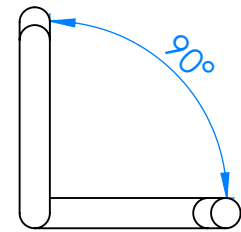
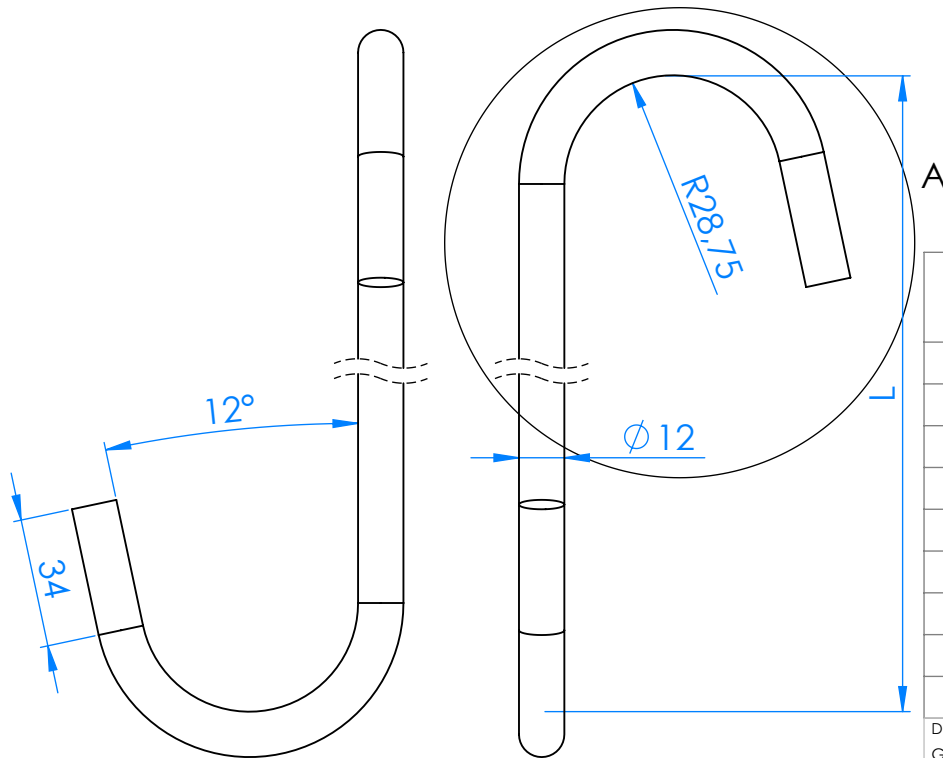
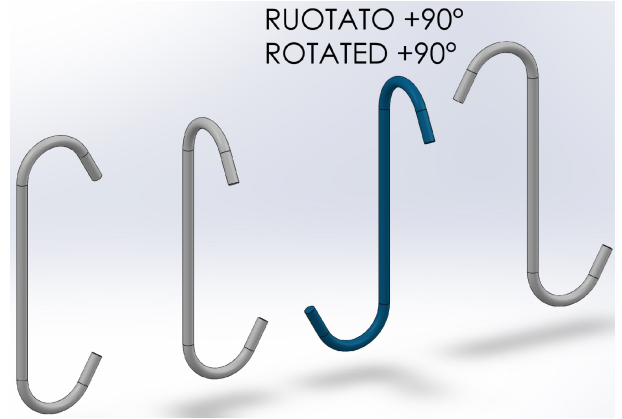
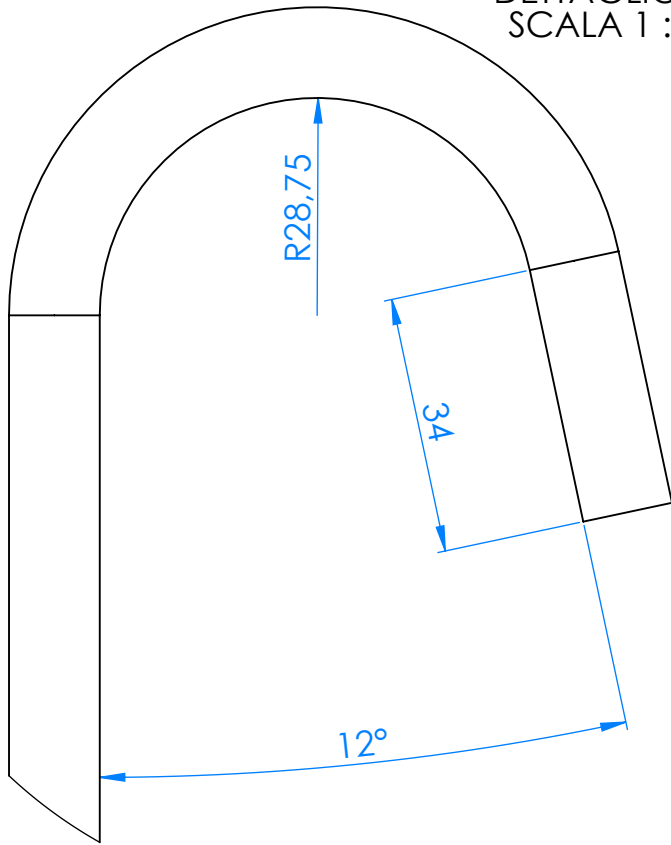

CODICE CODE	L(mm)
D12L150+C90.C	150
D12L200+C90.C	200
D12L250+C90.C	250
D12L300+C90.C	300
D12L400+C90.C	400
D12L500+C90.C	500
D12L600+C90.C	600
D12L800+C90.C	800
D12L1000+C90.C	1000

DESCRIZIONE / DESCRIPTION
GANCIO ACCIAIO "S355JR" Ø12, PIEGA STANDARD "C" ROT +90°
STEEL HOOK "S355JR" Ø12, STANDARD BENDING "C" TURN +90°

MATERIALE / MATERIAL

S355JR Laminato/S355JR Hot Rolled



SCALA / SCALE

1:2

FORMATO / SHEET SIZE

A4



Rostirolla s.r.l.